

WARNING

ELECTRIC RANDOM ORBIT SANDER

Any piece of equipment can be dangerous if not operated properly. **YOU** are responsible for the safe operation of this equipment. The operator must carefully read and follow any warnings, safety signs and instructions provided with or located on the equipment. Do not remove, defeat, deface, or render inoperable any of the safety devices or warnings on this equipment. If any safety devices or warnings have been removed, defeated, defaced, or rendered inoperable, **DO NOT USE THIS EQUIPMENT!!!**

 **WARNING:** Drilling, sawing, sanding or machining wood products can expose you to wood dust, a substance known to the State of California to cause cancer. Avoid inhaling wood dust and use a dust mask or other safeguards for personal protection. For more information go to www.P65warnings.ca.gov

WARNING!

- Never operate power equipment of any kind if you are tired or if you are under the influence of alcohol, drugs, medication or any substance that could affect your ability or judgment. Be alert! If you get tired while operating this equipment, take a break. Tiredness may result in loss of control.
- This 120-volt equipment may require a grounded outlet, do not modify plug.
- Always wear eye, dust, and hearing protection.
- Don't Abuse Cord - Never carry tool by cord, or yank it to disconnect from receptacle.
- Do not use around flammable liquids or gasses, sparks could cause fire or explosion.

SAFETY RULES:

1. Keep Work Area Clean - Cluttered areas and benches invite accidents.
2. Avoid Dangerous Environment - Don't use power tools in damp or wet locations. Keep work area well lit. Do not expose to rain.
3. Keep Children Away - All bystanders should be kept a safe distance from the work area.
4. Store Idle Tools - When not in use, tools should be stored in dry, high, or locked-up place, out of reach of children.
5. Don't Force Tool - It will do the job better and safer at the rate for which it was designed.
6. Use Right Tool - Don't force small tool or attachment to do the job of a heavy-duty tool.
7. Wear Proper Apparel - No loose clothing or jewelry to get caught in moving parts. Rubber gloves and footwear are recommended when working outdoors.
8. Use Safety Glasses. Also face or dust mask.
9. Don't Abuse Cord - Never carry tool by cord, or yank it to disconnect from receptacle.
10. Secure Work - Use clamps or a vise to hold work. It's safer than using your hand, and it frees both hands to operate tool.
11. Don't Overreach - Keep proper footing and balance at all times.
12. Maintain Tools with Care - Keep clean for best and safest performance. Follow instructions for lubricating and changing sandpaper.
13. Disconnect Tools - When not in use; before servicing; when changing sandpaper.
14. Avoid Accidental Starting - Don't carry plugged-in tool with finger on switch. Be sure switch is off when plugging in.
15. Outdoor Use Extension Cords - When tool is used outdoors, use only extension cords suitable for outdoors and so marked. Fifty feet maximum of 12-gauge cord. Be sure sander is grounded or double insulated.

If the person receiving this handout will not be the user of the equipment, forward these instructions to the operator. If there is any doubt as to the operation or safety of the equipment,

DO NOT USE!! CALL A TOOL SHED IMMEDIATELY!!!

FAILURE TO FOLLOW THESE INSTRUCTIONS COULD RESULT IN INJURY OR DEATH

Functional Description: Makita BO5041 Random Orbit Variable Speed Sander

CAUTION:

- Always be sure that the tool is switched off and unplugged before adjusting or checking function on the tool

Switch action

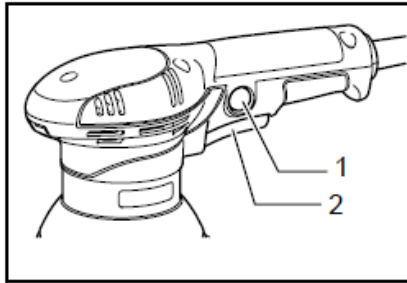

- 1. Lock button
- 2. Switch trigger

CAUTION:

- Before plugging in the tool, always check to see that the switch trigger actuates properly and returns to the “OFF” position when released.
- Switch can be locked in “ON” position for ease of operator comfort during extended use. Apply caution when locking tool in “ON” position and maintain firm grasp on tool.

To start the tool, simply pull the switch trigger. Release the switch trigger to stop.

For continuous operation, pull the switch trigger and push in the lock button and then release the switch trigger.

To stop the tool from the locked position, pull the switch trigger fully, then release it.

Speed adjusting dial

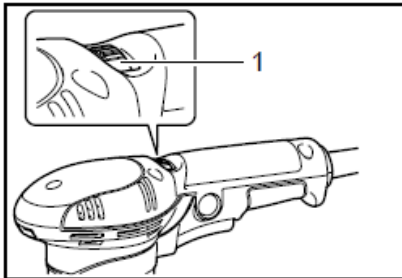

- 1. Speed adjusting dial

The tool speed can be infinitely adjusted between 4,000 and 12,000 orbits per minute by turning the adjusting dial. Higher speed is obtained when the dial is turned in the direction of number 5, lower speed is obtained when it is turned in the direction of number 1.

Refer to the figure for the relationship between the number setting on the adjusting dial and the kind of work.

A range: For polishing

B range: For finish sanding

C range: For regular sanding

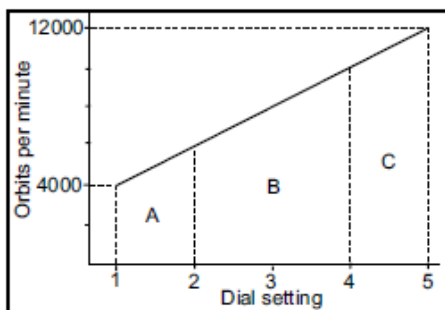

NOTE:

- The figure shows standard applications. They may differ under certain conditions.

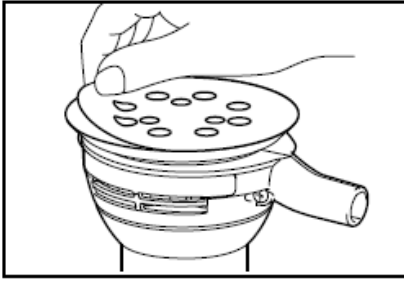

Installing or removing abrasive disc

To install the abrasive disc, first remove all dirt or foreign matter from the pad. Then align the holes in the hook and loop disc with the those in the pad and press them together firmly.

To remove the abrasive disc, starting at one edge pull back the worn pad until it is completely removed.

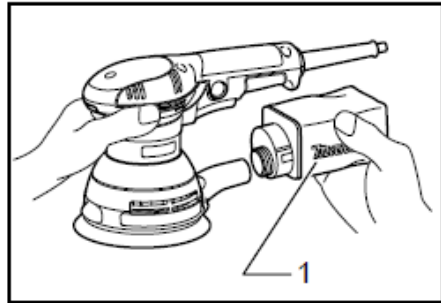

1. Dust bag

Installing dust bag

Install the dust bag on the tool so that the Makita logo on the dust bag will be upright (not upside down).

Emptying dust bag

When the dust bag is about half full, switch off and unplug the tool. Remove the dust bag from the tool. Then remove the dust nozzle from the dust bag after unlocking the dust nozzle by turning it slightly counterclockwise, Empty the dust bag

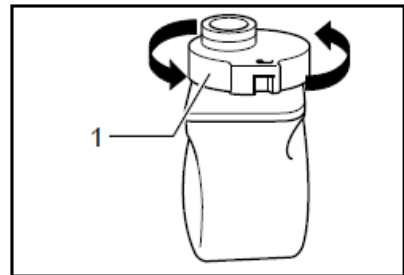

1. Dust nozzle

by tapping it lightly. After emptying the dust bag, install the dust nozzle on the dust bag. Turn the dust nozzle slightly clockwise to lock it in place. Then install the dust bag on the tool as described in “Installing dust bag”

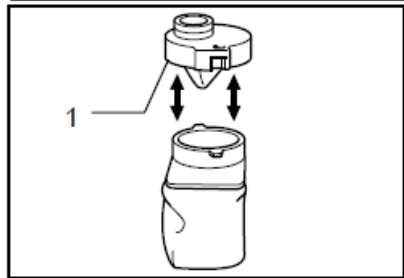

1. Dust nozzle

OPERATION

⚠ CAUTION:

- Always use the front grip and firmly hold the tool by front grip and switch handle during operations.

Sanding operation

⚠ CAUTION:

- Never run the tool without the abrasive disc. You may seriously damage the pad.
- Never force the tool. Excessive pressure may decrease the sanding efficiency, damage the abrasive disc, or shorten tool life.

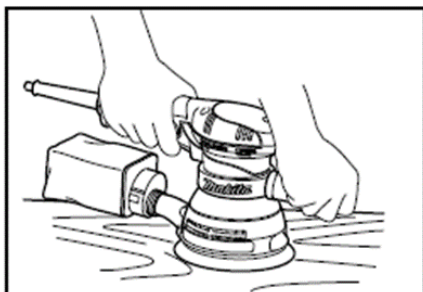

- Using the tool with a pad edge contacting the workpiece may damage the pad.

Hold the tool firmly. Turn the tool on and wait until it attains full speed. Then gently place the tool on the workpiece surface. Keep the pad flush with the workpiece and apply slight pressure on the tool.

⚠ CAUTION:

The sanding pad rotates clockwise during the loaded operation, but it may rotate counterclockwise during the no-load operation.