

General Safety Information

WARNING! Read and understand all instructions. Failure to follow all instructions listed below may result in electric shock, fire, and/or serious personal injury.

SAVE THESE INSTRUCTIONS!

Work Area Safety

- **Keep your work area clean and well lit.** Cluttered benches and dark areas invite accidents.
- **Do not operate tools in explosive atmospheres, such as in the presence of flammable liquids, gases, or dust.** Tools create sparks which may ignite the dust or fumes.
- **Keep by-standers, children, and visitors away while operating a tool.** Distractions can cause you to lose control.
- **Keep floors dry and free of slippery materials such as oil.** Slippery floors invite accidents.

Electrical Safety

- **Grounded tools must be plugged into an outlet, properly installed and grounded in accordance with all codes and ordinances. Never remove the grounding prong or modify the plug in any way. Do not use any adapter plugs. Check with a qualified electrician if you are in doubt as to whether the outlet is properly grounded.** If the tool should electrically malfunction or break down, grounding provides a low resistance path to carry electricity away from the user.

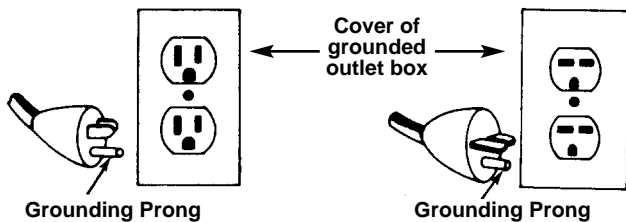

- **Avoid body contact with grounded surfaces.** There is an increased risk of electrical shock if your body is grounded.
- **Do not expose electrical tools to rain or wet conditions.** Water entering a tool will increase the risk of electrical shock.
- **Do not abuse cord. Never use the cord to pull the plug from an outlet. Keep cord away from heat, oil, sharp edges or moving parts. Replace damaged cords immediately.** Damaged cords increase the risk of electrical shock.

- **When operating a tool outside, use an outdoor extension cord marked “W-A” or “W”.** These cords are rated for outdoor use and reduce the risk of electrical shock.
- **Use only three-wire extension cords which have three-prong grounding plugs and three-pole receptacles which accept the tool’s plug.** Use of other extension cords will not ground the tool and increase the risk of electrical shock.
- **Use proper extension cords.** (See Chart) Insufficient conductor size will cause excessive voltage drop and loss of power.

Minimum Wire Gauge for Extension Cord			
Nameplate Amps	Total Length (in feet)		
	0 – 25	26 – 50	51 – 100
0 – 6	18 AWG	16 AWG	16 AWG
6 – 10	18 AWG	16 AWG	14 AWG
10 – 12	16 AWG	16 AWG	14 AWG
12 – 16	14 AWG	12 AWG	NOT RECOMMENDED

- **Keep all electric connections dry and off the ground. Do not touch plugs or tool with wet hands.** Reduces the risk of electrical shock.

Personal Safety

- **Stay alert, watch what you are doing and use common sense when operating a power tool. Do not use tool while tired or under the influence of drugs, alcohol or medications.** A moment of inattention while operating power tools may result in serious personal injury.
- **Dress properly. Do not wear loose clothing or jewelry. Contain long hair. Keep your hair, clothing and gloves away from moving parts.** Loose clothes, jewelry or long hair can be caught in moving parts.
- **Avoid accidental starting. Be sure switch is off before plugging in.** Plugging in tools that have the switch ON invites accidents.
- **Remove adjusting keys or wrenches before turning the tool ON.** A wrench or a key that is left attached to a rotating part of the tool may result in personal injury.
- **Do not overreach. Keep proper footing and balance at all times.** Proper footing and balance enables better control of the tool in unexpected situations.
- **Use safety equipment. Always wear eye protection.** Dust mask, non-skid safety shoes, hard hat or hearing protection must be used for appropriate conditions.

Tool Use and Care

- **Use clamp or other practical way to secure and support the workpiece to a stable platform.** Holding the work by hand or against your body is unstable and may lead to loss of control.
- **Do not force tool. Use the correct tool for your application.** The correct tool will do the job better and safer at the same rate for which it is designed.
- **Do not use if switch does not turn the tool ON or OFF.** Any tool that cannot be controlled with the switch is dangerous and must be repaired.
- **Disconnect the plug from the power source before making any adjustments, changing accessories or storing the tool.** Such preventive safety measures reduce the risk of starting the tool accidentally.
- **Store idle tools out of the reach of children and other untrained persons.** Tools are dangerous in the hands of untrained users.
- **Maintain tools with care. Keep cutting tools sharp and clean.** Properly maintained tools with sharp cutting edges are less likely to bind and are easier to control.
- **Check for misalignment or binding of moving parts, breakage of parts and any other condition that may affect the tool's operation. If damaged, have the tool serviced before using.** Many accidents are caused by poorly maintained tools.
- **Use only accessories that are recommended for your tool.** Accessories that may be suitable for one tool may become hazardous when used on another tool.
- **Keep handles dry and clean; free from oil and grease.** Allows for better control of the tool.

Service

- **Tool service must be performed only by qualified repair personnel.** Service or maintenance performed by unqualified repair personnel could result in injury.
- **When servicing a tool, use only identical replacement parts. Follow instructions in the Maintenance Section of this manual.** Use of unauthorized parts or failure to follow maintenance instructions may create a risk of electrical shock or injury.

Specific Safety Information

▲ WARNING

Read this operator's manual carefully before using the 700 Power Drive. Failure to understand and follow the contents of this manual may result in electrical shock, fire and/or serious personal injury.

Call Ridge Tool Company, Technical Service Department at (800) 519-3456 if you have any questions.

Power Drive Safety

- **The Power Drive is made to turn threaders and other equipment. Follow instructions in this Operator's Manual on proper use when threading. When using it to power other equipment, read and follow the safety and operating instructions provided with that equipment.** Other uses may increase the risk of serious injury.
- **When threading one inch or larger pipe, secure Power Drive using a No. 775 Support Arm. Hold Power Drive firmly. If the Power Drive cannot be secured by a Support Arm, use other mechanical means such as a pipe wrench.** Resists high handle forces developed during use and prevents losing control of the tool.
- **Do not use this power drive if switch is broken.** This switch is a safety device that lets you shut off the motor by removing your finger.
- **Do not wear gloves or loose clothing when operating Power Drive. Keep sleeves and jackets buttoned. Do not reach across rotating tool parts or workpiece.** Clothing can be caught resulting in entanglement and serious injury.
- **When using to power equipment other than threaders, the 700 Power Drive may have to be secured to resist high handle forces.** Handle forces that are developed will depend on the application. High handle forces may cause serious injury.
- **Do not use dull or damaged dies.** Sharp cutting dies require less torque and the Power Drive is easier to control.

Description, Specifications and Standard Equipment

Description

The RIDGID Model 700 Power Drive provides rotational motion for threading pipe, conduit and rod (bolt stock) and other purposes. Forward and Reverse rotation can be selected with the REV/OFF/FOR switch.

The Power Drive is designed for use with the No. 12R Die Heads (1/8" – 2" pipe). Other RIDGID drop head die heads (00R, 00-RB, 11R) and RIDGID Geared Threaders (2 1/2" – 6") require the use of adapters. A manual oiling system is available to flood the work during the threading operations. The No. 775 Support Arm should be used to secure the Power Drive and resist high handle forces developed when threading one inch or larger pipe with drop head die heads.

The RIDGID Model 700 Power Drive can also be used in other applications such as to power the RIDGID 258 Pipe Cutter and to turn valves. These applications require the use of the No. 774 Square Drive Adapter.

Specifications/Standard Equipment

Threading Capacity

Pipe and Conduit.....Drop Head Die Heads: 1/8" – 2";
Geared Threaders: 2 1/2" – 6",
No. 00-RB Die Head: 1/4" – 1"

Motor:

TypeUniversal

Horsepower1/2 HP

Volts115V Single Phase AC, 25-60
HZ (230V On Request)

Amps13 amps

Switch.....2-Pole, Double Throw (Reversible), Spring Return to Center OFF Position

Operating Speed32 RPM (no load)

Gear Head.....All Spur-gear Reduction.
Spring-loaded Adapter Pawls.
Hardened Steel Spindle Gear

BodyGear Case, Motor Housing and
Handle Are Cast Aluminum.

Length28 1/4"

Weight25 lbs.

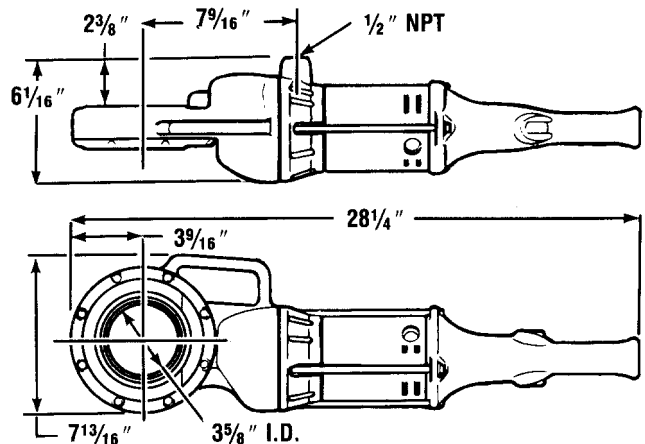

Figure 2 – No. 700 Power Drive

Catalog No.	Model No.	Description	Weight	
			lb.	kg.
41935	700	115V, 25-60 HZ	25	11
41940	700	230V, 25-60 HZ	25	11

Accessories

No. 12-R Die Heads (9) ..1/8", 1/4", 3/8", 1/2", 3/4", 1", 1 1/4",
1 1/2", 2"

No. 418 OilerOiler with 1 Gallon RIDGID
Thread Cutting Oil

No. 775 Support Arm.....Absorbs Power Drive Handle
Forces

Carrying CaseFor Power Drive and Die Heads

No. 460 Tristand Chain Vise

Adapters for Drop Head Die Heads

Die Head Model No.	Pipe and Conduit Capacity	Use Adapter Model No.
12-R	1/8" through 2"	—
OO-R	1/8" through 1"	770
O-R	1/8" through 1"	771
11-R	1/8" through 1 1/4"	772
111-R	1/8" though 1 1/4"	773

OO-RB	1/4" though 1"	770
-------	----------------	-----

Geared Threaders

Threader Model No.	Pipe and Conduit Capacity	Use Adapter Model No.
141	2 1/2", 3", 3 1/2" & 4"	774
161	4", 4 1/2", 5" & 6"	774

Power Drive Inspection

▲ WARNING



To prevent serious injury, inspect your Power Drive. The following inspection procedures should be performed on a daily basis:

1. Make sure Power Drive is unplugged.
2. Inspect the power cord and plug for damage. If the plug has been modified, is missing the grounding pin, or if the cord is damaged, do not use the Power Drive until the cord has been replaced.
3. Inspect the Power Drive for any broken, missing, misaligned or binding parts as well as any other conditions which may affect the safe and normal operation of the tool. If any of these conditions are present, do not use the Power Drive until the condition has been repaired.
4. Lubricate the Power Drive if necessary according to the Maintenance Instructions.
5. Use tools and accessories that are designed for your Power Drive and meet the needs of your application. The correct tools and accessories allow you to do the job successfully and safely. Accessories suitable for use with other equipment may be hazardous when used with this Power Drive.
6. Clean any oil, grease or dirt from all equipment handles and controls. This reduces the risk of injury due to a tool or control slipping from your grip.
7. Inspect the cutting edges of your dies. If necessary, have them replaced prior to using the Power Drive. Dull or damaged dies can lead to poor quality threads.
8. Clean metal shavings and other debris from the chip tray of the 418 Oiler. Check the level and quality of the thread cutting oil. Replace or add oil if necessary.

NOTE! Thread cutting oil lubricates and cools the threads during the threading operation. A dirty or poor grade cutting oil can result in poor thread quality and increased threading torque.

Tool and Work Area Set-Up

▲ WARNING

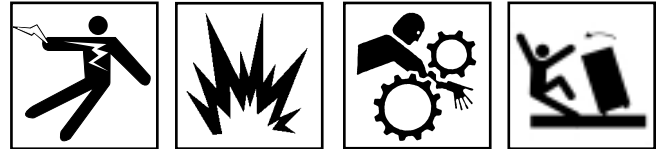

To prevent serious injury, proper set-up of the Power Drive and work area is required. The following procedures should be followed to ensure proper set-up of the tool.

1. Locate a work area that has the following:
 - Adequate lighting
 - No flammable liquids, vapors or dust that may ignite.
 - Grounded electrical outlet
 - Clear path to the electrical outlet that does not contain any sources of heat or oil, sharp edges or moving parts that may damage electrical cord.
 - Dry place for operator. Do not use the Power Drive while standing in water.
 - Level ground for trisland vise and pipe stands.
2. Clean up the work area prior to setting up any equipment. Always wipe up any oil that may have splashed or dripped from the oiler to prevent slips and falls.
3. Plug the Power Drive into the electrical outlet making sure to position the power cord along the clear path selected earlier. If the power cord does not reach the outlet, use an extension cord in good condition.

▲ WARNING To avoid electrical shock and electrical fires, never use an extension cord that is damaged or does not meet the following requirements:

- The cord has a three-prong plug similar to shown in Electrical Safety section.
- The cord is rated as “W” or “W-A” if being used outdoors.
- The cord has sufficient wire thickness (14 AWG below 25’/12 AWG 25’ - 50’). If the wire thickness is too small, the cord may overheat, melting the cord’s insulation or causing nearby objects to ignite.

▲ WARNING To reduce risk of electrical shock, keep all electrical connections dry and off the ground. Do not touch plug with wet hands.

4. Check the Power Drive to insure it is operating properly.
 - Depress the switch and make sure it controls the stopping of the Power Drive by releasing the switch.

- Depress and hold the switch. Inspect the moving parts for misalignment, binding, odd noises or any other unusual conditions that may affect the safe and normal operation of the tool. If such conditions are present, have the Power Drive serviced.
- Depress switch in the opposite direction. Check that the Power Drive rotates in the opposite direction.

Operating Instructions For Threading With Drop Head Die Heads

▲ WARNING



Do not wear gloves or loose clothing when operating Power Drive. Keep sleeves and jackets buttoned.

Do not use this Power Drive if the switch is broken. Always wear eye protection to protect eyes from dirt and other foreign objects.

When threading pipe one inch or larger, use the No. 775 Support Arm or other mechanical means to resist high handle force developed during threading.

1. Push Die Heads or Adapters, spline end first, squarely into the Power Drive until the spring-loaded adapter pawls catch securely (Figure 3).

NOTE! Installation can be made into either side of the Power Drive.

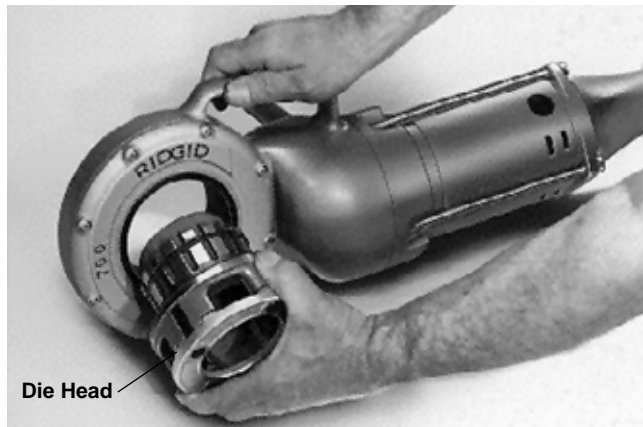

Figure 3 – Installing No. 12-R Drop Head Die Head

2. If possible, secure the pipe in a portable trisand vise or a bench vise.

▲ WARNING To prevent tipping, long lengths of pipe should also be supported with pipe stand.

3. Be sure the 418 Oiler is properly filled with RIDGID Thread Cutting Oil. Position the oiler in front of the vise (Figure 4).
4. Position No. 775 Support Arm on pipe so end of tang is in line with end of the pipe (Figures 4 & 5). Make sure jaws squarely contact pipe and tighten handle firmly to prevent the slipping of the jaws.

▲ WARNING To avoid serious injury from losing control of the Power Drive, a support arm should be used when threading one inch or larger pipe.

If the No. 775 Support Arm is not available or cannot be properly attached to the pipe, a pipe wrench may be used by securing the wrench to the pipe and contacting the Power Drive's auxiliary handle (Figure 6). Position wrench a sufficient distance from the Power Drive to allow for the desired length of thread to be cut.

When threading pipe less than one inch in size without a support arm, hold onto the Power Drive firmly with one hand to exert pressure against the handle forces developed during threading.

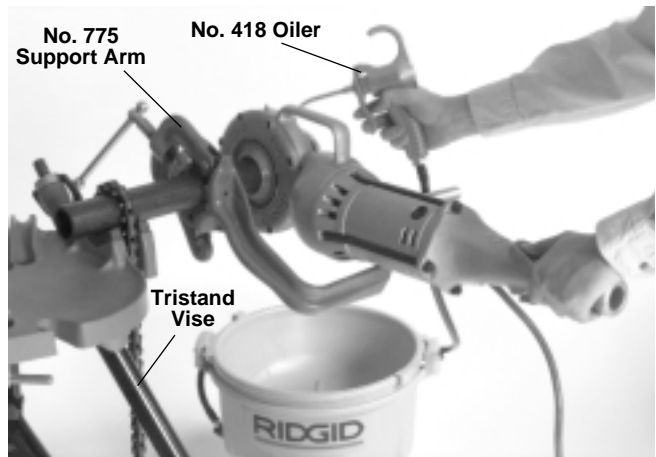

Figure 4 – Threading 2" Pipe With Power Drive Positioned On Left Side Of Vise

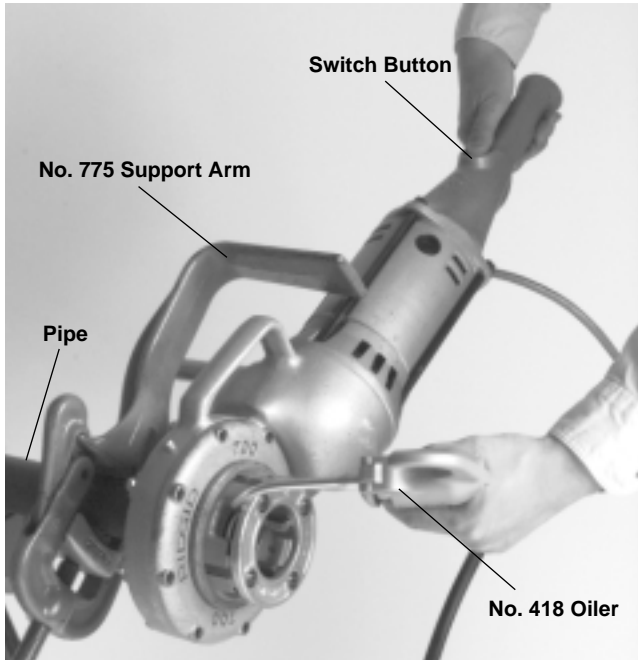

Figure 5 – Threading 2” Pipe With Power Drive Positioned On Right Side Of Vise



Figure 6 – Threading Using Pipe Wrench As A Support Arm

5. Place Die Head over end of pipe.

▲ WARNING To avoid serious injury, make sure Power Drive is correctly positioned on support arm (*Figures 4, 5 & 6*). For right hand threads, Die Head will rotate clockwise (looking at the face of the Die Head). Forces developed by the threading torque will be in the opposite or counter-clockwise direction.

6. Simultaneously actuate the switch button and exert pressure against the Die Head with the palm of free hand to make sure thread is started. Apply plenty of thread cutting oil to the dies during threading. This will

reduce the torque required to thread and improve the thread quality.

7. Keep switch depressed until end of the pipe is even with edge of the dies and release the switch button.
8. Back off the Die Head from the threaded pipe by actuating the switch button in the reverse direction.

▲ WARNING To avoid injury, hold onto the Power Drive handle firmly to resist handle forces developed while backing off the Die Head.

9. When dies clear the end of the pipe, grip the handle on top of the Power Drive and remove the Power Drive and Die Head from the pipe.
10. Remove the support arm from the pipe and the pipe from the vise.

▲ WARNING To avoid injury, make sure long sections of pipe are supported at the end farthest away from the vise prior to removal.

11. Clean up any oil spills or splatter on the ground surrounding the vise and oiler.

Operation Instructions For Threading With Geared Threaders



▲ WARNING
Do not wear gloves or loose clothing when operating Power Drive. Keep sleeves and jackets buttoned. Do not reach across the geared threader.

Do not use this Power Drive if the switch is broken. Always wear eye protection to protect eyes from dirt and other foreign objects.

To prevent tipping, proper set-up of the Power Drive and Geared Threader is required. Follow instructions carefully.

Geared Threaders weigh 95 to 160 pounds. Two (2) persons should be used to lift these threaders.

Adjusting Nos. 141 And 161 Geared Threaders

Cam Plate (Pipe Size) Adjustment Procedure

1. Place threader on floor or workbench with drive shaft up.

Troubleshooting

WARNING: Always unplug power cord before servicing Power Drive.

PROBLEM	CAUSE	CORRECTION
Motor does not start	Power Drive unplugged	Plug into power source
	Fuse blown	Install new fuse
	Brushes do not touch armature	Check brushes, replace if worn
Motor sounds overloaded	Overload because of dull dies	Replace dies
	Bad quality or insufficient thread cutting oil	Use RIDGID thread cutting oil in adequate quantity
Sparks forming at motor	Bad contact between brushes and brush holder	Tighten the screws, make sure brush is pressed firmly onto commutator
	Brushes do not touch commutator properly	Replace worn brushes
	Brushes of different manufacture	Only use original brushes
	Sharp edge on brush	Break edge
Die head does not start threading	Dull or broken dies	Replace dies
	Machine running in wrong direction	Check setting of the direction switch
	Improperly set dies	Reset dies
Damaged Thread	Dull dies	Replace dies
	Dies not assembled in correct sequence	Put dies in correct sequence
	Low quality pipe	Make sure only pipe of good quality is used
	Bad quality or insufficient thread cutting oil	Use only RIDGID thread cutting oil in adequate quantity
Support arm turns while threading	Support arm feedscrew not tight	Tighten feedscrew
	Support arm jaws dirty	Clean with wire brush
	Support arm not square on pipe	Make sure sits square on pipe
Die heads cannot be changed properly	Burr has occurred at the spline end of the die head	Eliminate burr with file

WARNING: HAND POWER THREADER

Any piece of equipment can be dangerous if not operated properly. **YOU** are responsible for the safe operation of this equipment. The operator must carefully read and follow any warnings, safety signs and instructions provided with or located on the equipment. Do not remove, defeat, deface or render inoperable any of the safety devices or warnings on this equipment. If any safety devices or warnings have been removed, defeated, defaced or rendered inoperable, **DO NOT USE THIS EQUIPMENT!!!**

 **WARNING:** This threader can expose you to chemicals including naphthalene and sulfur from cutting oil products which are known to the State of California to cause cancer and birth defects or other reproductive harm. For more information go to www.P65warnings.ca.gov

If the person receiving this handout will not be the user of the equipment, forward these instructions to the operator. If there is any doubt as to the operation or safety of the equipment

DO NOT USE!!! CALL A TOOL SHED IMMEDIATELY!!!
**FAILURE TO FOLLOW THESE INSTRUCTIONS COULD
RESULT IN INJURY OR DEATH**