

1 ½" BRANCH CHIPPER WARNING SAFETY

Any piece of equipment can be dangerous if not operated properly. **YOU** are responsible for the safe operation of this equipment. The operator must carefully read and follow any warnings, safety signs and instructions provided with or located on the equipment. Do not remove, defeat, deface or render inoperable any of the safety devices or warnings on this equipment. **IF** any safety devices or warnings have been removed, defeated, defaced, or rendered inoperable, **DO NOT USE THIS EQUIPMENT!!!**

⚠ WARNING: Operating, servicing, and maintaining this equipment can expose you to chemicals including engine exhaust, carbon monoxide and lead, which are known to the State of California to cause cancer and birth defects or other reproductive harm. To minimize your exposure, avoid breathing exhaust, do not idle the engine except as necessary, operate and service your equipment in a well-ventilated area and wear gloves or wash your hands frequently when servicing your equipment. For more information go to www.P65warnings.ca.gov

MISUSE WARNING

This chipper is for tree branches and only! You are responsible for any damage caused by nail, metal, dirt or sand embedded wood, wire, rocks, etc. Over feeding or putting piles of leaves or debris in the hopper will slow the cutter wheel causing it to jamb. This misuse will damage the belts and the centrifugal clutch. **Misuse Is Not Covered by The Equipment Protection Plan.**

ALWAYS WEAR SAFETY GLASSES EAR AND FACE PROTECTION **IMPORTANT SAFETY RULES TO FOLLOW**

⚠ WARNING Before starting the Chipper. Make sure the area has been secured to keep bystanders clear and out of the restricted/operator's only area. (At least a 50-foot diameter circle around the Chipper) If necessary, use barricades, cones, delineator posts & caution tape. Check to see that all the belt guards are in place & that the infeed hopper is positively attached & is clear of any foreign objects.

STOP DANGER When operating the Chipper never wear loose fitting clothing or gloves that do not fit your hands snugly. Never wear gauntlet type gloves (examples, long cuffed lineman's or welder's gloves) Loose fitting clothes can become entangled in the chippers moving parts or branches pulling you into the Chipper resulting in dismemberment or death. Always wear personal protective equipment including, hardhat, safety shoes, eye and face protection, ear protection and gloves. **CONTACT WITH THE CUTTER WHEEL CAN KILL OR DISMEMBER.**

⚠ WARNING beware of limbs & chips that can be kicked back or thrown out of hopper. If working near traffic, wear high visibility clothing.

⚠ WARNING Never push short branches, twigs or leaves into the Chipper. When you are feeding a longer branch simply toss the smaller pieces on top. The longer branch will pull them into the chipper automatically.

STOP DANGER NEVER REACH INTO THE HOPPER! If a feeding problem should occur shut machine down & wait until the cutting wheel comes to a complete stop before resolving the problem. Do the same before refueling, cleaning or transporting.

ATTENTION Whenever feeding limbs into Chipper, feed butt end first. This practice will decrease the problem of wedging or jamming in hopper.

⚠ CAUTION Always keep the chipper on level ground. Always block both tires front & rear. The chipper must be operated on a firm, level surface.

STOP DANGER Fuel and fumes can catch fire or explode and cause burns. Make sure engine is turned off and cooled down before refueling. Prevent fires by keeping engine compartment; battery, fuel tank and operator's station clean of trash, grease, and debris. Exhaust fumes can be fatal. Work outdoors only.

If the person receiving this handout will not be the user of the equipment, forward these instructions to the operator. IF there is any doubt as to the operation or safety of the equipment, DO NOT USE!!! CALL A TOOL SHED IMMEDIATELY!!! FAILURE TO FOLLOW THESE INSTRUCTIONS COULD RESULT IN INJURY OR DEATH

1. Operator safety warnings



A number of symbols are used in this user manual to provide additional information and to highlight dangers.

1.1 For your information



For your information:

This symbol is used to draw your attention to specific information and/or actions, or to denote where you can find additional information relating to the subject.

1.2 Caution



Caution:

This notice identifies safe usage habits. This is done to prevent incorrect actions that can result in personal injury or damage to the machine.

1.3 Warning



Warning:

This notice is used to denote danger to consider in these specific circumstances. Thus remain alert, in order to ensure your own safety.

2. Main parts

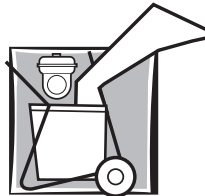

To fully grasp the contents of this operator's manual, you need to be thoroughly familiar with the terminology used for the descriptions. In this chapter you can find a set of parts identified by name.

It's a good idea to take time to study the machine beforehand for an improved understanding of the descriptions given in this user's manual.

2.1 Machine survey

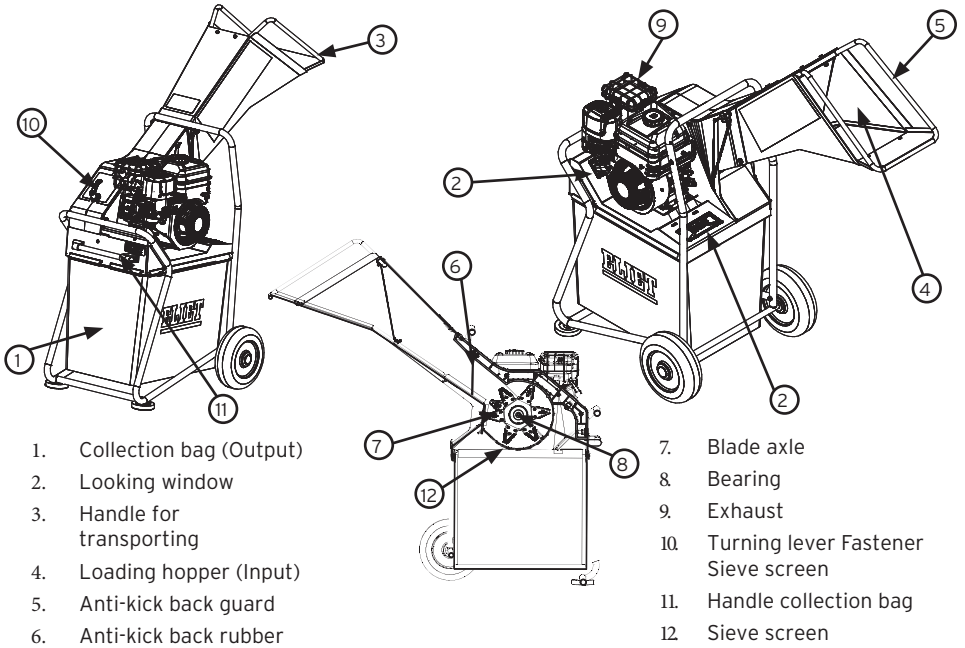

3. Safety regulations



3.1 Safety messages



Decal location : On the left side of the loading hopper. This decal is used to denote all the safety precautions using icons.

1. Read this owner's manual carefully in its entirety before attempting to operate this unit.
2. Always wear the appropriate protective garment when operating the machine (protective gloves, safety goggles, hearing protectors).



These icons are pictured on the left side of the loading hopper. They warn for the danger of cutting injuries to hands and to the danger of kickback material. Do not put your hands passed the safety protection screen.

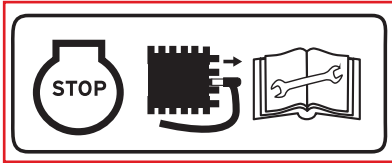

These icons are pictured on the left side of the loading hopper.

When performing a maintenance to the machine, always turn off the engine. Put the switch on the engine to the OFF-position, in order to provide accidentally turning on the engine. Do not allow third parties near the machine while performing a maintenance. Always read the user manual before performing a maintenance to the machine or to the engine.

3.2 Safety features

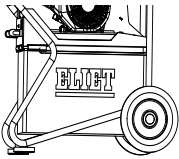

The collection bag:

The collection bag is located on the underside of the machine. Remove the collection bag and the motor automatically shuts off. In so doing, the collection bag prevents you from inserting your hands into the rotating shred knives. In order to prevent the collection bag from opening when shredding, it is locked in its position with a powerful magnet.



Warning:

The knives may continue to rotate for a few seconds after the engine is shut off. Wait for 15 sec. before starting an intervention. Be careful not to cut your hands.

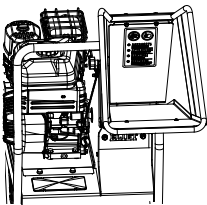

Safety screen:

The steel sheet located within the infeed opening, is specially designed to protect the operating personnel against flying wood chips. Any attempt by the operator to insert his hands beyond this steel sheet is strictly forbidden.

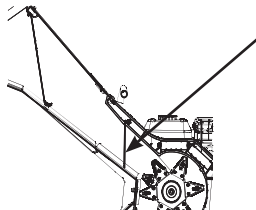

Anti-projection rubber:

At the entrance of the shredding chamber there is a synthetic flap that limits de fly-back of chips out of the chipping chamber. It is also a last shielding against involuntary contact with the blades

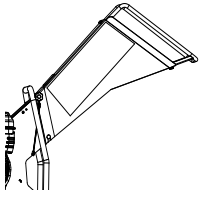

Loading hopper:

The shape of the loading hopper ensures the safety of the operator and is a protection against his personal carelessness. If the operator ignores the warning, and inserts his hands beyond the debris deflector shield, then this hopper impedes access to the shredding chamber in as much as injury caused by the shredding knives through the infeed opening is virtually impossible.

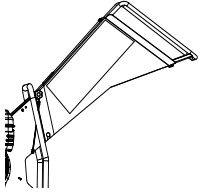

Safety switch on the loading hopper:

To be able to store the machine compact, the loading hopper is removable. To prevent accidents from happening when the machine is working, a safety switch was installed. It shuts down the engine automatically as soon as the screws of the hopper are loosened. This also prevents the machine from being used without the loading hopper.

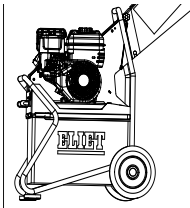

Rugged construction:

The robust construction not only adds to the long operating life of the machine but also provides extra user safety whenever there is an unforeseen emergency.

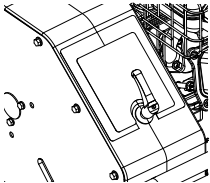

Sound absorption:

The double-walled acoustic housing accommodating the knife drum gives excellent noise reduction whilst shredding, therefore, minimising noise nuisance for both the operator and the surroundings.

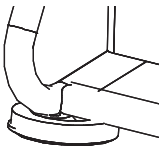

Rubber support feet:

The rubber support feet absorb vibrations of the machine, and they also have a restricting function. A machine on a slope will not slide down.

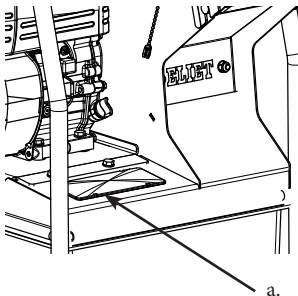

Looking window: a.

In the top plate of the chassis a sight glass is provided so that the user can control at all times in a safe way the volume in the collection bag.

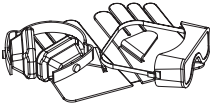

Safety wear:

For your safety, we strongly recommend to use the safety kit supplied as standard. It contains your Personal Protective Equipment (PPE) : that is, safety goggles, ear defenders and protective gloves.

3.3 General Safety Precautions

- The owner must retain the manual during the complete service life of the machine. It serves as a reference for the user, therefore, enabling the machine to be used and maintained in accordance with the correct instructions.
- This machine is designed solely for shredding branchy material, pruning, leaves and all kinds of organic garden debris. Any use other than the designated operation is at the risk and responsibility of the operator.
- According to the manufacturer, this model will take branches up to 1&1/2" diameter. Branch feed is not mechanically limited to this stated capacity ; it follows that any attempt to introduce thicker branches must be avoided. For your own safety on no account should any attempt be made to introduce stems thicker than the stated capacity.
- Never attempt to shred branches that are frozen.



Warning:

Accepting branches with diameter up to 1&1/2" , this machine, however, is not designed for continuous shredding to the stated capacity. In the interest of your own safety, it is recommended that only 10% of the green waste exceeds this diameter.

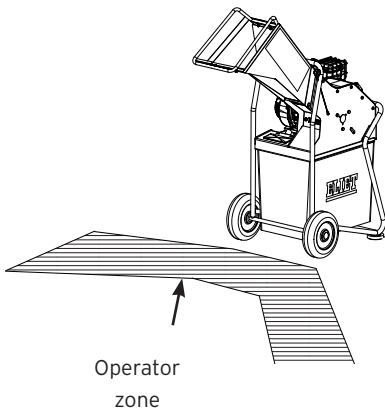

- This equipment must only be operated when stationary. Here, make sure the tyres and the frame are brought into contact with the ground.
- The operator's position when shredding is the surrounding area within arm reach located on the front of the infeed opening.
- Never use a step for feeding the machine with material.
- The equipment must under no circumstances be modified.
- Do not use the machine without loading hopper
- Observe all safety instructions when using the ELIET machine ! Carefully read the instructions on using the machine. All these instructions relate to your personal safety.

4. Operating instructions

4.1 Preliminary checks



Caution:

Before commencing the work, it is recommended to get into the habit of checking the following points.

Checklist

1. Check the oil level of the machine. To this effect, remove the dipstick and make sure the oil level has not fallen to danger level
2. Check ample petrol in tank beforehand. If not, add fuel
3. Make sure that the orifices of the air cleaner are not clogged
4. Satisfy yourself that the shredding knives are firmly in place and in good condition. If they need to be sharpened, this must be done first. Check the knives for cracks and nicks and replace immediately as needed
5. Check whether the screen at the rear of the machine is secure, and has been fastened in the correct manner.
6. Verify that all of the machine's safety items are operating correctly.

Once these items have been checked and approved, you can prepare the area of operation and move the machine to the work site.

4.2 Filling up with Petrol

Top up if the machine runs short of petrol. Use only clean, fresh gasoline. Use lead free fuel, gasoline with a minimum of 98 or 99 octane is to be preferred.



Warning:

Under certain conditions, gasoline is extremely flammable and extremely explosive. Fire and explosion caused by gasoline can result in serious burns or damage to property.

Thus, always take note of the following points.

- Never fill tank when engine is running.
- Topping up with gasoline may never occur while an engine is running. Always allow a few minutes for the engine to cool off before topping up with fuel.
- Use only fresh gasoline. In order to reduce air pollutant emissions, ELIET recommend lead-free gasoline. In order to extend storage life, mix additives with the fuel.
- Store fuel only in an approved container. Keep this container out of reach of children
- Never top up gasoline at a location where work will be performed later. Always keep the area of operation clear of all persons (30 ft minimum). This is to prevent any fire risk.
- Clean the fuel fill area first and then remove this cap. Never fill a tank to over 85% of the tank's capacity. Top up allowing approximately 3/8" of tank space. Thus, do not fill the tank completely to the opening in the tank.
- Always use a funnel or spout to pour the petrol into the tank. Suitable funnels can be obtained from your ELIET Dealer.
- Refit the cap onto the tank. If petrol is spilled during the filling, the engine must be immediately cleaned.
- When gasoline has been spilled one will avoid this comes into contact with the viewing Windows. Gasoline can react with the plastic and affect the transparency or strength of the viewing Windows. Cracked or damaged viewing Windows have to be replaced. They can no longer guarantee safe use.
- Be careful not to spill petrol onto clothing. Should clothing become contaminated be careful to change clothes as soon as possible.
- It is unsafe and therefore expressly forbidden from filling the fuel tank in the vicinity of smokers or an open flame.
- If fuel comes into contact with the eyes or is taken internally, get prompt medical attention.

4.3 Preparing the operating area

- Clear the area first where the machine is to be used. In addition, the paths along which the plant trimmings are removed, must be kept clear, thus releasing the operator from the worries of tripping up over them. The operator must also ensure that his safety is not compromised.
- On slopes, never operate the machine (no forward or lateral slope).
- Sort out as much as you can before you start the machine up. In this way, you are pretty sure that no foreign objects will enter the machine with the material to be shredded.
- With foreign objects are meant : any non-organic object or branchy material in excess of the stated capacity (such as metal, stone, plastic, pvc, cords,...). Some of these can cause serious damage to your machine or can be ejected, virtually as projectiles towards the user.
- Always position the machine so that the wind will blow the dust produced away from the engine.
- Also, check which way the wind is blowing to make sure the exhaust fumes will be blown away from the operator's position.

4.4 Starting the Petrol Engine



Caution:

Never start never the machine if dust or dirt lies on the engine between the cooling fins or is present on the engine. This prevents optimal cooling of the engine and more importantly can cause fire.

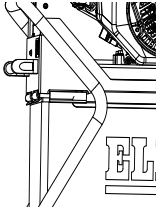

You will be unable to start the engine as long as the collection bag hasn't been pushed fully in the chassis and locked in position and the load hopper is mounted correctly.



For your information:

Also, read the engine manual. In the chapter entitled General you can find more information on the key engine functions.

- Before starting the engine, check if there is adequate oil and fuel in the engine.
- It is essential to ensure that the loading hopper is free of any material.

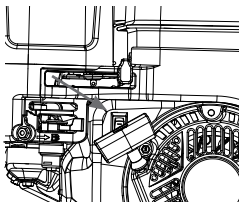

On-position

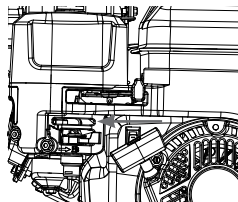

Choke

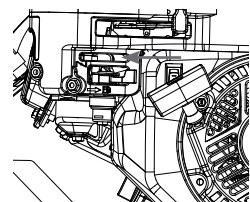

Throttle control

- Open the fuel shut-off valve by turning it in the ON position.
- Adjust the throttle control lever fully to the right to full speed.
- Move the throttle control lever to the CHOKE position, therefore, closing the choke



Warning:

Before starting up the machine, make sure to wear ear protection.

- Start the engine by giving the recoil starter cord a strong pull. After the engine is running, quickly move the choke lever to RUN. This ensures that the engine does not receive too much petrol. If you forget to do this, then the engine will slow down and start to smoke profusely. Eventually, it will stop. Restart the engine without choke.
- When engine starting is problematic, it signifies that the spark plug is fouled. It follows that the spark plug needs cleaning or replacing.



Warning:

The knife drum is driven directly by the engine. The knives remain engaged. This means that the machine becomes dangerous as soon as the engine starts running. Therefore the engine must be switched off immediately whenever you encounter a situation in which you lose control.

How to Quickly Turn off the Machine ?

- Through moving the engine throttle control lever to the left (see engine manual).
- Sliding the unlocked collection bag backward will also cause the engine to shut off.

4.5 Using the Machine

4.5.1 Before Starting Work

- Wear proper apparel, protective gloves and safety equipment as instructed in this manual.
- A good gardener is well organised and plans his work. This will enable him to have an overview of the work and to avoid accidents and incorrect actions with the machine..
- The wood is systematically stacked before commencing the work : thick branches, thin branches, leaves and damp material. Ensure that the material does not contain any foreign objects.
- The engine must only be started once arrived at the work site.
- Never run the machine in an enclosed area. If this is done, there is a danger of being poisoned by the fumes from the engine..
- Always adjust throttle to full speed (throttle control lever to the right).
- After the motor has started, allow it to warm up. This ensures that the motor attains its full power. The importance of this cannot be overstressed when shredding branchy material of maximum branch size.



Caution:

Once the engine is running, the shredding knives are rotating, therefore, irrevocably shredding anything that is introduced into the loading hopper.

4.5.2 During the work

- You must be careful when performing work. As long as you're operating the machine, focus your concentration completely on the work.
- When inserting the material, always hold it firmly. The rotational direction of the knife drum makes for steady material feed into the hopper. If you stop holding the wood firmly, it will automatically be pulled much too quickly into the machine which will inevitably lead to the machine stalling.
- You yourself will thus control the speed at which the wood is fed in (faster or slower). The speed at which the wood is fed in will vary according to branch size.
- You will listen attentively to the characteristics of the motor when feeding in the wood. If you notice a significant drop into engine speed, immediately pull the wood back out in order to allow the engine to speed up again.



Caution:

When feeding in wood, never insert your hands beyond the steel shield. By raising the safety screen, you are no longer protected against wood chips flying out of the machine.

- If the equipment is primarily used for shredding leaves or damp material using the standard sieve screen, the chances are good that orifices will clog.
- If only a small volume of leaves is to be processed, they can be easily shredded using the standard screen. However, in this case, ELIET recommend that leaves and branches should be shredded alternately. In so doing, the wood chips prevent the screen orifices from clogging.
- As the waste chippings are collected in a collection bag, care must be taken in making sure at regular intervals that the chips will not block the discharge situated on the underside of the machine. Collection bag filling can be checked by looking through the plastic window.
- To promote collection bag consolidation, shake the bag regularly to distribute the waste chippings to fill the empty spaces in the collection bag.
- If you should notice that, despite all of the preparation, a foreign object still finds its way into the machine, the engine must be immediately shut off. The foreign object must be removed first and then the machine must be examined for damage. If damaged, have the damage repaired promptly.
- As a rule, the engine will shut off automatically on removing the collection bag. If not, possibly as the result of an electrical defect, immediately turn the engine off yourself and refrain from using it until repaired.

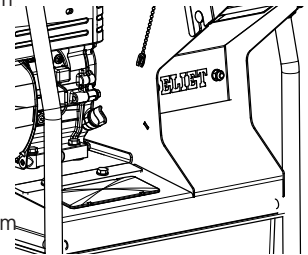

REMOVING THE COLLECTION BAG = MOTOR SHUT OFF

Normally, the engine shuts off if the feed hopper is loosened. If this is not the case, the machine operator will turn off the machine manually with the switch on the motor. The defect must be fixed immediately before proceeding the work.

REMOVING THE FEED HOPPER = MOTOR SHUT OFF

4.6 Emptying the collection bag

- The bag needs emptying when the waste chippings in the collection bag have reached the bottom of the discharge chute of the machine.
- In order to do so, always first make sure to shut off the engine (failure to do so will cause the engine to cut out automatically on collection bag removal).
- Failure to empty the bag in time will cause the shredding chamber to get clogged up and finally come to a stop .



Caution:

A machine that does clog up is a sure source of overheating with the resultant increase in fire hazard.

- The collection bag has an approximative 16 gallon capacity.



Warning:

Once full, the collection bag can be pretty heavy. Which means - make sure to hold the collection bag close in towards your body as close as possible first and then lift using your leg muscles. (Lift keeping back straight and bend legs at the knees.) Know your own capability. The mere fact of lifting things beyond your personal capacity a mere few inches does serious damage. Seek assistance when lifting things that are too heavy for you.

- Either you can empty the contents of the collection bag in to a wheel barrow, or you can carry the full bag to the dumping area using the wheel barrow.
- What's more, the machine can be used for transporting the collection bag once full.
- When refitting the collecting bag you can secure it in position using locating pins.

4.7 What To Do about Engine Stalling

Engine stalling can be traced to overloading, overfeeding, discharge blockage or lack of fuel. The engine may well not restart immediately. To remedy the problem, do the following.

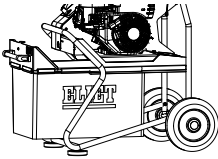

1. Check ample petrol in tank.
2. Remove all branches from the feeding aperture.
3. Pull the starter rope briefly. This allows you to find out whether the knife drum is still jammed. As soon as you feel resistance, and cannot pull the starter rope any further, stop pulling. There is no point in pulling hard on the starter rope, as this can only cause it to break or overload the starter mechanism.
4. When the knife drum got jammed, the shredding chamber needs clearing.



Warning:

The knives are razor sharp, avoid cuts to the hands. Wear gloves !



Caution:

Be attentive when tilting the machine that no gasoline is leaking away.

5. Remove all wood chips and traces of wood that are in the shredding chamber. Chips that have accumulated on the top can be loosened by pulling the starter cord of the engine, To remove the chips that have accumulated on the top side, pull the starter cord of the engine slightly so the blade axle ejects the chips. Please note: avoid the presence of anyone else near the machine.

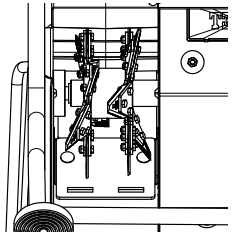

6. Carefully refit the shredding screen and check for correct refitting.
7. Refit the collection bag and restart the shredder.
8. Perform the work more carefully in the future in order to avoid jamming of the machine.

If you notice a strange noise during shredding, immediately stop the work. Stop the engine and investigate the cause of the defect. Before proceeding, perform the necessary repairs.

5. Transporting the machine



- Make sure to clear the shredding chamber before moving the machine. Make sure the infeed opening is free of branchy material.
- When moving the machine over greater distances (over 6 feet), always take care to turn off the engine.
- The chipper is designed to be in stationary position while working. This means that both the wheels and support legs are on the ground. To transport the machine you have to put it in transport position. To do this, grab the handle to the funnel and tilt the machine to the front till it is in a balanced position. (The handle is on + 24" of the ground).

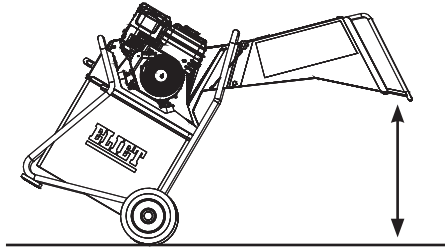

- Then, grasp the chassis upper tube with your left hand while holding the loading hopper handle with your right hand. In so doing, you can hold the machine with a firm grip for smooth pulling and pushing.
- Only adults may move or transport the machine.
- Also, during the transport, do not allow children, unauthorized persons or animals within a radius of 16 feet around the machine.
- The in feed hopper can be disassembled for an easier transportation of the machine in a car.
- To slide the wheel holder out of the frame, tilt the machine 6 inch over the support feet till the wheels are about 6 inch above the ground. Put your foot on the connection tube between the wheels and push it down out of the chassis. (First, check whether the wheel holder is not secured to the right lower side with a pressure screw (M8)).
- Use slip resistant ramps to load the machine into a van or a trailer. Ensure that these are well secured to the vehicle or trailer.
- Assure yourself the parking brake of the vehicle is on before loading the machine.
- Under no circumstances must the angle of the ramp be greater than 25°.
- Be careful and composed when loading and unloading the shredder so that the machine does not tip over and give rise to an accident.
- In the event that the machine does tip over, right it again as soon as possible. This prevents oil from leaking out of the crankcase on to the air cleaner.
- Try to prevent the motor from falling over, since these filters are expensive.

• When walking up a slope push the chipper out in front of you with you facing uphill.

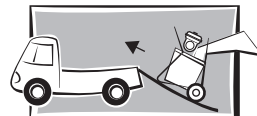

• When walking down a slope, move down backwards with you facing the machine.

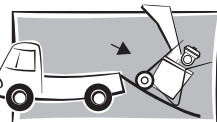

• The machine must be properly tied down within the vehicle during transport. Use the tube-gear to attach ropes.

• Do not overload the vehicle.

• The maximum allowable lateral slope angle amounts to 10°